



ASSAM POWER GENERATION CORPORATION LIMITED

Registered Office: Bijulee Bhawan, 2nd floor, Paltanbazar, Guwahati-781 001, Assam.

Email: egmh2010@yahoo.in, Tele-Fax: 0361-2739522.

Ratnajit Biswanath

Chief General Manager (Hydro & Civil)

No. APGCL/CGM (H&C)/W/2018-19/668/69

Date: 01/06/2020

Corrigendum

Please supersede the Tender Notice No. 27 of 2019-20 of CGM (H&C) dated: 19.03.2020 and extension notice no. APGCL/CGM (H&C)/W/2018-19/668/68 dtd. 27/05/2020 regarding the work "Additional and supplementary work for construction of Causeway near weir Stage-I, Myntriang SHEP, APGCL, Karbi Anglong"

Corrigendum:

Name of work: In the NIT under the heading "Name of work", for Sl no. 1 the line should be read as "Construction of approach road, widening and boulder pitching upstream of Causeway MSHEP, Stage-I" instead of "Additional and supplementary work for construction of Causeway near weir Stage-I, Myntriang SHEP, APGCL, Karbi Anglong".

The scope of work and all items and terms & conditions including technical specifications shall remain same.

To make the work more specific, additional drawings no. I and II has been enclosed as Annex-A. These drawings shall be read in conjunction with the earlier drawings enclosed with the NIT.

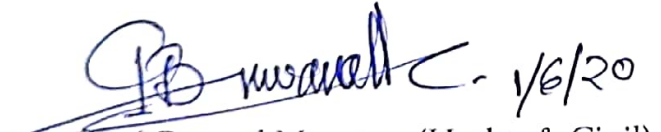
Chief General Manager (Hydro & Civil),
APGCL

Copy to: -

- 1) The Managing Director, APGCL, Bijulee Bhawan, Paltanbazar, Guwahati-1, for favour of kind information.
- 2) The Chief General Manager (F&A), APGCL, Bijulee Bhawan, Paltanbazar, Guwahati-1, for information.
- 3) The General Manager, Design (Civil), APGCL, Narengi, Guwahati-781 026, for information and wide circulation.
- 4) The Deputy General Manager, Investigation Circle, APGCL, Narengi, Guwahati-781 026, for information and wide circulation.
- 5) The GM, KLHEP, APGCL, Karbi Anglong, for information and wide circulation.
- 6) The Project Manager, MSHEP, APGCL, Dist- KarbiAnglong for information and necessary action.
- ✓ 7) Relevant File.

Drawing - I

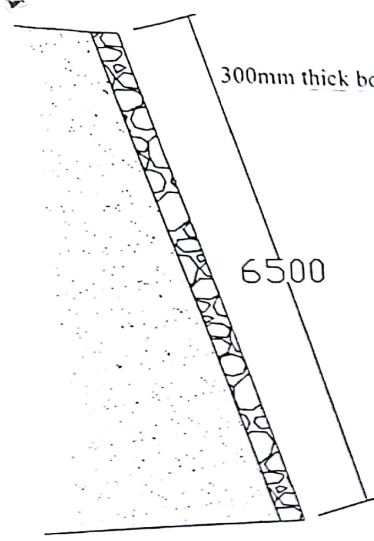

From 0m to 13m towards weir
Length=13m

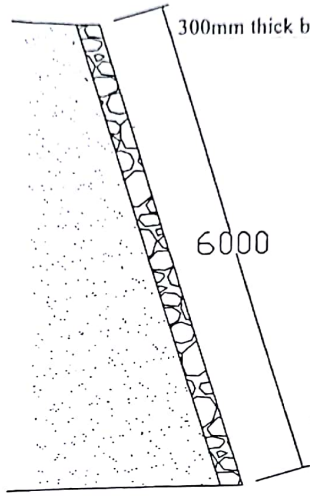

From 13m to 26m towards weir
Length=13m

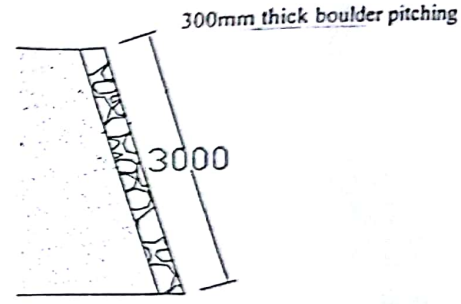

From 26m to 39m towards weir
Length=13m

CROSS SECTION FOR LEFT BANK ABUTMENT PITCHING (U/S SIDE)

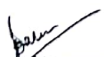
Asst. Manager (C)
Myntiriang S.H.E. Project
APGCL, Lengery, W. K/A.

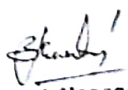
Project Manager (C)
Myntiriang S.H.E. Project
APGCL, Lengery, K/A.

Drawing - II

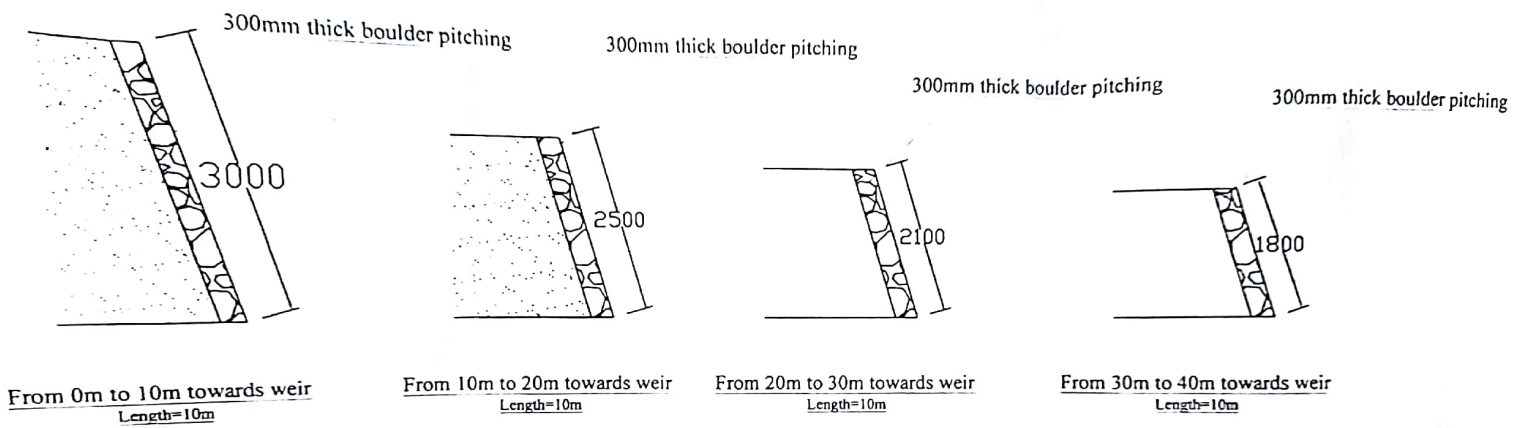

CROSS SECTION FOR RIGHT BANK ABUTMENT PITCHING (U/S SIDE)

Asstt. Manager (C)
Myrntiang S.H.E. Project
APGCL, Lengery, W. KJA.

Project Manager
Myrntiang S.H.E. Project
APGCL, Lengery, KJA.